

P-27xx Series

Models:

P-2701RL VoIP ATA / Gateway with Lifeline

P-2702R VoIP ATA / Gateway

User's Guide



Default Login Details

IP Address	http://192.168.1.1
User Name	admin
Password	1234

Firmware Version 1.01
Edition 1, 09/2010

www.zyxel.com

ZyXEL

Introduction

1.1 Overview

This guide helps you set up and use your ZyXEL Device (either the P-2702R VoIP ATA / Gateway or the P-2701RL VoIP ATA / Gateway with Lifeline).

This guide contains the following sections:

SECTION	PAGE	DESCRIPTION
Installation Requirements	5	A checklist of things you need before you install the ZyXEL Device.
Making Hardware Connections	6	How to connect the ZyXEL Device to your network, your computer and telephone(s).
Initial Configuration	9	How to configure your ZyXEL Device to access the Internet and make Voice over Internet (VoIP) phone calls. For the P-2701RL, it also explains how to set up regular phone services that do not use the Internet.
Placing Phone Calls	15	How to make calls from the phone(s) connected to the ZyXEL Device.
Advanced Phone Configuration	16	How to configure advanced VoIP options.
Speed Dial Settings	24	How to create a list of speed dial numbers.
Dial Plan with URL	26	How to create a list of peer-to-peer call numbers.
Supported Phone Functions	27	A table of the key combinations you can enter on your phone's keypad to use certain features.
System Mode and Accounts	31	How to change your operating mode (router or bridge) and system passwords.
Auto-Provision	33	How to save the ZyXEL Device auto-provisioning file and configure the ZyXEL Device to download the configuration and firmware automatically from an auto-provisioning server.
TR-069 Setting	34	How to configure the ZyXEL Device to be managed over the WAN by an Auto Configuration Server (ACS).
Troubleshooting	37	Possible solutions for any issues that may arise.
Specifications	43	Information about your ZyXEL Device's physical specifications
Features	44	Supported firmware specifications.

SECTION	PAGE	DESCRIPTION
Wall Mounting Instructions	47	How to attach the ZyXEL Device to a wall.
Safety Warnings	49	Using the ZyXEL Device safely.
Open Software Announcements	49	Description of ZyXEL's open software use and where to download open source components modified by ZyXEL.
Legal Information	51	Certifications, warranty and customer support information.

1.2 How It Works

The following figure shows how the ZyXEL Device works:

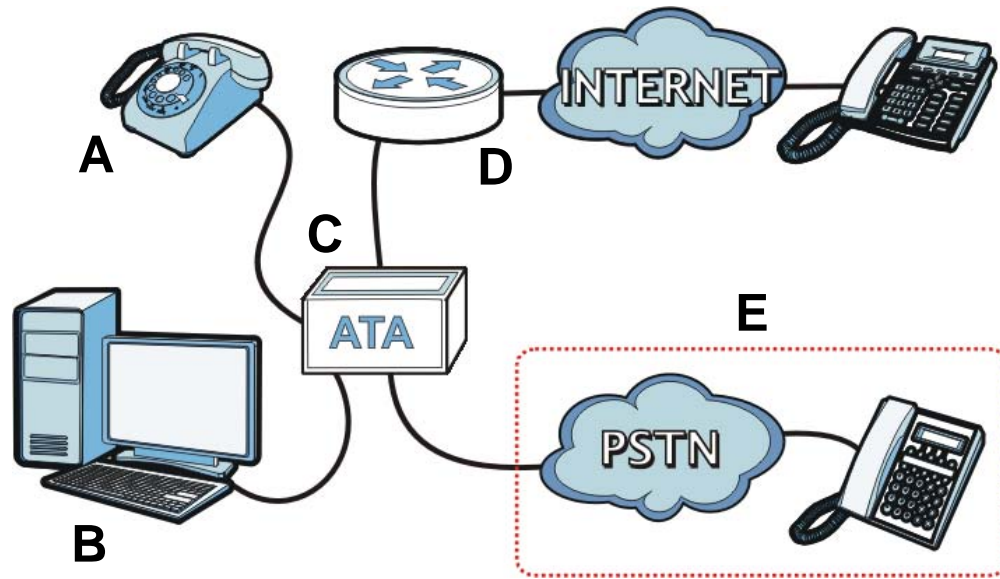

- When you make a phone call over the Internet, you use a telephone (A) to dial the number. The P-2701RL supports one telephone connection, and the P-2702R supports two telephone connections.

The telephone is connected to your ZyXEL Device (C), which is connected to the broadband modem or router that provides Internet access (D).

- When you want to use the Internet, you use your computer (B). Your computer is connected to your ZyXEL Device (C), which is connected to the broadband modem or router that provides Internet access (D).

You also use your computer to configure the ZyXEL Device.

- **P-2701RL Only (E):** Use your telephone (A) to make calls over the regular telephone network (PSTN or Public Switched Telephone Network).

Important information about your ZyXEL Device:

Default Management IP Address	192.168.1.1
Default Subnet Mask	255.255.255.0
Default Admin User Name	admin
Default Admin Password	1234
Default User Name	user
Default User Password	user

1.3 Installation Requirements

Make sure you have the following things before you set up your ZyXEL Device:

- Internet Account - Information provided by your ISP (the company that lets you connect to the Internet). This information might include your user name, password, and so on.
- VoIP Account - Information provided by your VoIP service provider (the company that lets you make phone calls over the Internet). This information might include your URI, number, and so on.
- Web Browser - Internet Explorer 6.0 or later or Firefox 1.5 or later with JavaScript enabled.

1.4 Making Hardware Connections

The following shows you how to make the ZyXEL Device's hardware connections.

Figure 1 P-2701RL Hardware Connections

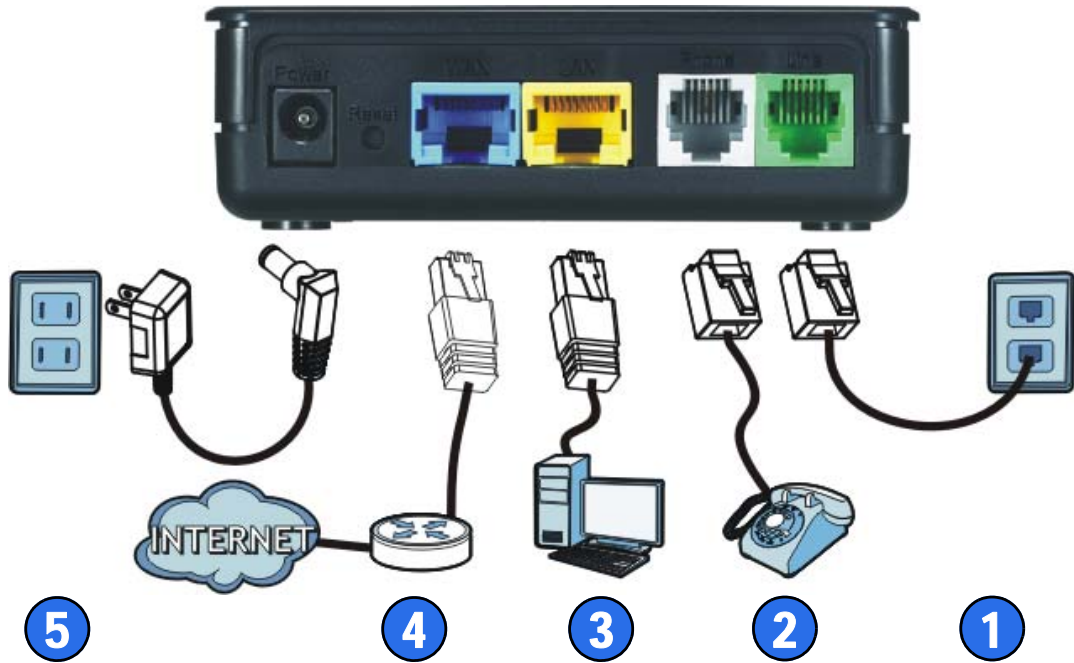
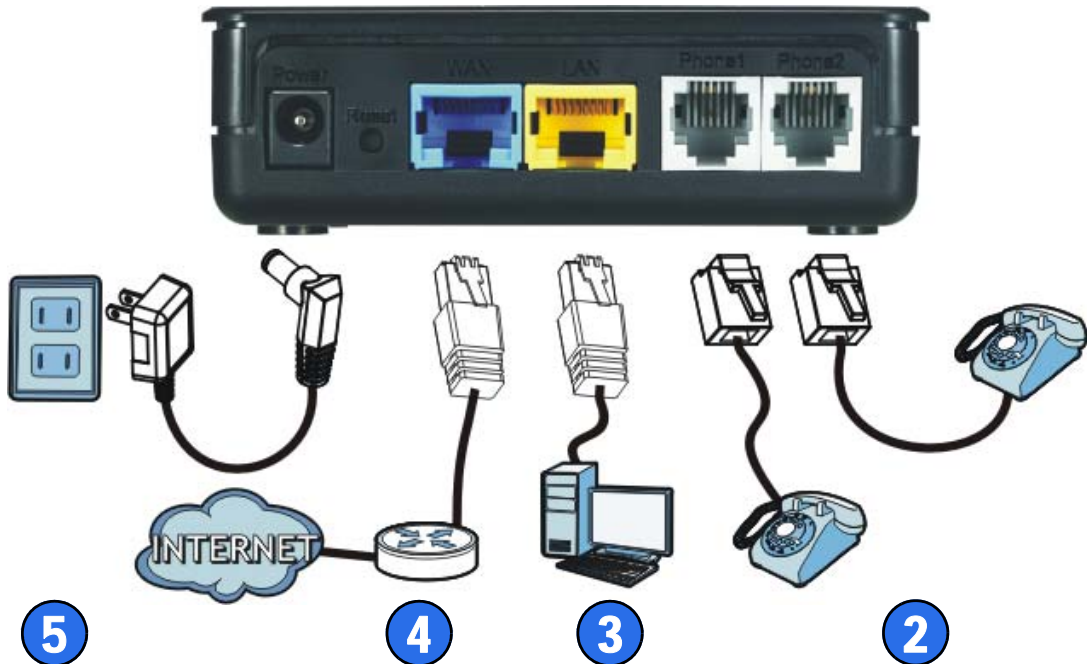

Figure 2 P-2702R Hardware Connections



- 1 **LINE (P-2701RL only)**: Use a telephone cable to connect the telephone jack (or the TEL or PHONE jack on a splitter, if one is already installed) to this port.
- 2 **PHONE 1 / PHONE 2**: Use a telephone cable (and any telephone adaptor provided with your ZyXEL Device) to connect your telephone to this port.
- 3 **LAN**: Use an Ethernet cable to connect your computer to this port.
- 4 **WAN**: Use an Ethernet cable to connect your broadband modem or router to this port.
- 5 **POWER**: Use the power adaptor provided with your ZyXEL Device to connect an appropriate power source to this jack.

On the front panel, the **POWER** light flashes green while your ZyXEL Device starts up, and stays green once it is ready. The **WAN** and **LAN** lights turn on if the **WAN** and **LAN** ports are properly connected. These lights flash when the ZyXEL Device is sending or receiving data.

Initial Configuration

This chapter shows you how to set up your ZyXEL Device by connecting to its built-in Web Configurator with your computer.

2.1 The Web Configurator

The web configurator is an HTML-based management interface that allows easy device setup and management via a web browser.

To connect to the Web Configurator:

- 1 Launch your web browser.
- 2 Enter <http://192.168.1.1> as the address.

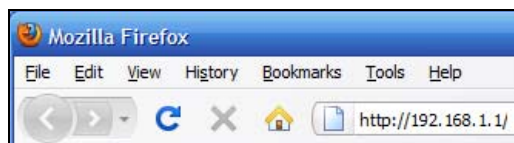

- 3 Enter the default administrator **Username** (admin) and **Password** (1234), then click **Login**.



- 4 Click **Go to Wizard setup**.

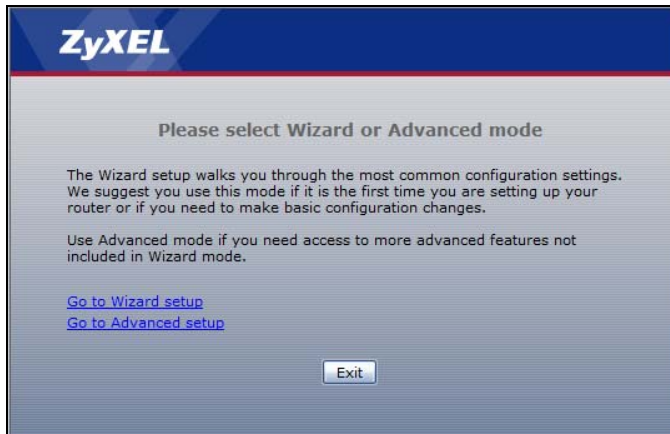

- 5 The **Configuration Wizard** opens.



2.2 The Connection Wizard

This section shows you how to configure your Internet connection settings using the Connection Wizard.

Note: You must have an active Internet account with a service provider in order to complete this section.

- 1 In the **Wizard Setup** screen, select **Connection Wizard**.
- 2 In the **Welcome** screen, click **Next**.

- 3 In the **Time Zone Setting** screen, select **Enable NTP Client Update** if you want to maintain the ZyXEL Device's internal clock by synchronizing it with a time server.

Time Zone Setting

You can maintain the system time by synchronizing with a public time server over the Internet.

NTP type

Enable NTP client update

Time Zone Select : (GMT+08:00)Taipei

NTP server : 192.5.41.41 - North America

If you do this, choose a **Time Zone** and an **NTP Server** closest to your location from their respective menus, then click **Next** to save your settings and go to the next screen.

- 4 The **WAN Interface Setting** screen has different fields, depending on the type of Internet access your ISP uses.

WAN Interface Setting

This page is used to configure the parameters for Internet network which connects to the WAN port of your Access Point. Here you may change the access method to static IP, DHCP, PPPoE, by click the item value of WAN Access type.

WAN IP

WAN Access Type: PPPoE

User Name: examplename

Password:

You can choose either **Static IP**, **Dynamic IP**, or **PPPoE**:

- **Static IP** means the ISP has assigned your Internet access account a single IP address that will never change, regardless of whether you are online or not. See [Section 2.2.1 on page 12](#) for details.
- **Dynamic IP** allows the ISP to randomly assign your ZyXEL Device an IP address each time it requests a WAN (or Internet) session. The IP address is released as soon as the ZyXEL Device disconnects from the ISP. See [Section 2.2.2 on page 12](#) for details.
- **PPPoE** emulates a standard dial-up connection over the Internet and requires that each time the ZyXEL Device requests a WAN session you log in with your ISP-assigned user name and password. See [Section 2.2.3 on page 12](#) for details.

Choose the setting required by your ISP then follow the instructions in the appropriate section below. If you are not sure which setting to use then contact your ISP.

2.2.1 Static IP Connection Settings

Follow these steps if your ISP uses a static IP connection.

- 1 Select **Static IP** from the **WAN Access Type** menu. The screen changes to provide options for this setting.

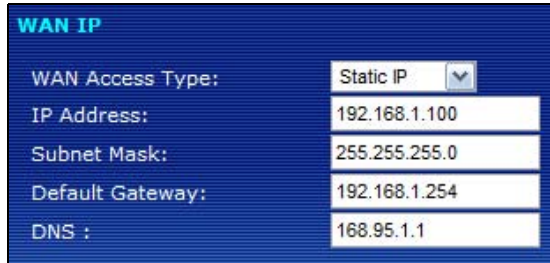

The screenshot shows a configuration window titled "WAN IP" with a blue background. It contains the following fields:

WAN Access Type:	Static IP
IP Address:	192.168.1.100
Subnet Mask:	255.255.255.0
Default Gateway:	192.168.1.254
DNS :	168.95.1.1

- 2 Enter the settings as provided by your ISP.
- 3 Click **Finished** to save your settings.

2.2.2 DHCP Connection Settings

Follow these steps if your ISP uses a dynamic IP connection.

- 1 Select **Dynamic IP** from the **WAN Access Type** menu.

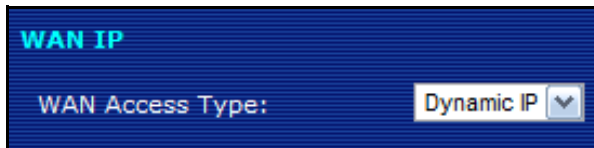

The screenshot shows a configuration window titled "WAN IP" with a blue background. It contains the following field:

WAN Access Type:	Dynamic IP
------------------	------------

- 2 Click **Finished** to save your settings.

2.2.3 PPPoE Connection Settings

Follow these steps if your ISP uses a PPPoE connection.

- 1 Select **PPPoE** from the **WAN Access Type** menu. The screen changes to provide options for this setting.

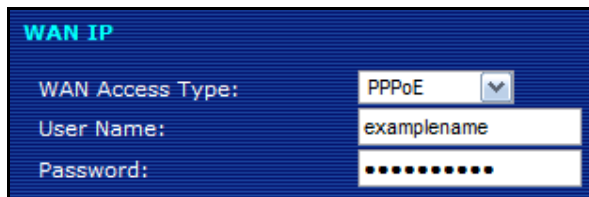

The screenshot shows a configuration window titled "WAN IP" with a blue background. It contains the following fields:

WAN Access Type:	PPPoE
User Name:	examplename
Password:	••••••••

- 2 Enter the **User Name** and **Password** assigned to you by your ISP.
- 3 Click **Finished** to save your settings.

2.2.4 Test Your Internet Connection

Open another tab in your web browser and go to any web site (for example, <http://www.zyxel.com>).



If you cannot access after using the configuration settings provided by your ISP, see [Troubleshooting](#) on page 37.

2.3 The VoIP Setup Wizard

This section shows you how to configure your voice-over-Internet settings using the VoIP Setup wizard.

Note: You must have Internet access and a VoIP account before you can complete this section.

- 1 In the **Wizard Setup** screen, select **VoIP Setup**.
- 2 In the **VoIP Configuration** screen, enter the information provided by your VoIP service provider.

A screenshot of the "Phone 1 SIP Settings" configuration screen. The screen has a dark blue background with white text and input fields. It is divided into two sections: "Phone 1 SIP Settings" and "Authentication". Under "Phone 1 SIP Settings", there are three input fields for "SIP Number", "SIP Server Address", and "SIP Service Domain". Under "Authentication", there are two input fields for "User Name" and "Password".

If you have a VoIP account like "1234@VoIP-provider.com", the **SIP Number** is "1234", and the **SIP Service Domain** is "VoIP-provider.com". If your VoIP service provider did not provide information for any of the fields in this screen, leave them at their default settings.

- P-2702R Only:** The **Phone 2 SIP Settings** screen appears next. If you want to set up a second VoIP account, select **Enable SIP** then enter the information for the second VoIP account as you did for the first one in step 2.



Phone 2 SIP Settings

Enable SIP

SIP Number

SIP Server Address

SIP Service Domain

If you do not want to configure a second VoIP account at this time, you can do so later in the **VoIP > SIP > SIP Settings** screen of the advanced Web Configurator.

- Click **Finish** to save your settings.

2.3.1 Test Your VoIP Connection

After you finish configuring your VoIP account (s), the wizard tests your SIP account settings then indicates whether or not they are valid. If they are not, try re-configuring them.

	REG Status
Phone 1	Reg Success

If you still cannot access after using the settings provided by your VoIP service provider see [Troubleshooting](#) on page 37.

Phone Use and Configuration

This chapter describes basic phone setup and usage, as well as select advanced VoIP configuration options for your ZyXEL Device.

3.1 PSTN Phone Set Up (P-2701RL Only)

When one of your VoIP accounts is registered, the ZyXEL Device normally uses the Internet (VoIP) rather than the regular PSTN phone line to place and receive phone calls.

However, if you connect the **Line** port to a regular PSTN phone jack, then incoming PSTN calls will be forwarded directly to the phone connected to your ZyXEL Device's **Phone** port.

3.2 Placing Phone Calls

Use the following sections to make outgoing calls from a phone attached to the ZyXEL Device to another phone.

Follow these directions to make calls over the Internet:

- If you want to dial a SIP number that only uses numbers (for example, "12345"), dial the number on your phone's keypad. You can also set up a speed-dial entry, if you want, in the **VoIP > Phone Book > Speed Dial** screen. See [Section 3.4 on page 24](#) for more information.
- If you want to make a peer-to-peer call, set up a dial plan with URL entry first. Use the **VoIP > Phone Book > Dial Plan with URL** screen. Then dial the pre-configured SIP number to make the call to a peer VoIP device directly. See [Section 3.5 on page 26](#) for more information.
- If you want to call a PSTN phone over the Internet, follow your VoIP provider's instructions.

3.3 Advanced Phone Configuration

Click **VoIP > SIP** to open the **SIP Settings** screen. This screen allows you to manage up to two SIP accounts.

Figure 3 The SIP Settings Screen

The screenshot shows the SIP Settings screen with the following sections:

SIP Account	Active	Account Name	User ID	Proxy Server	Modify	Copy Setting
SIP 1	<input type="checkbox"/>					CopyToSIP2
SIP 2	<input type="checkbox"/>					CopyToSIP1

NAT Traversal

STUN Enable

STUN Server Address

STUN Server Port

Set User Header To Phone

Set User Header To Phone Enable

Bind T.38 RTP Port

Assign Port for Reinvite Use Original RTP Port

Apply Reset

To have the ZyXEL Device add a “user=phone” parameter to the SIP URI before sending a SIP INVITE request, select the **Enable** option next to **Set User Header To Phone**. This parameter indicates the user part of the SIP URI (<user>@<sipserver>) the ZyXEL Device is calling is a valid telephone number.

If you need to send fax messages using T.38 and want to always use the same port number for both transmitted and received T.38 packets, select **Use Original RTP Port**. Otherwise, select **Assign Port for Reinvite** to have the ZyXEL Device choose a port randomly for T.38 after the re-invite process.

Click **Apply** to save the changes you made in this screen.

Select **Active** for the phone you want to configure, then click the **Modify** icon. The **Phone SIP Settings** screen opens, where you can set up and maintain your SIP account(s) in the ZyXEL Device. Your VoIP or Internet service provider should provide you with your account information.

Figure 4 The Phone SIP Settings screen

The following table describes the labels in this screen.

Table 1 SIP Setting

LABEL	DESCRIPTION
Active SIP Account	Select this if you want the ZyXEL Device to use this account. Clear it if you do not want the ZyXEL Device to use this account.
Account Name	Enter a descriptive name for this SIP account. You can use up to 127 printable ASCII characters.
Number	Enter your SIP number. In the full SIP URI, this is the part before the @ symbol. You can use up to 127 printable ASCII characters.
SIP Display Name	Enter the name that appears on the other party's device if they have Caller ID enabled. You can use up to 127 printable ASCII characters.
SIP Server Address	Enter the IP address or domain name of the SIP server provided by your VoIP service provider. You can use up to 95 printable ASCII characters.
SIP Server Port	Enter the SIP server's listening port number, if your VoIP service provider gave you one. Otherwise, keep the default value.
SIP Service Domain	Enter the SIP service domain name. In the full SIP URI, this is the part after the @ symbol. You can use up to 95 printable ASCII Extended set characters.
Register Expire (sec)	Enter the maximum amount of allotted time for the ZyXEL Device to attempt to register with the SIP server.

Table 1 SIP Setting (continued)

LABEL	DESCRIPTION
Outbound Proxy Server	Select this if your VoIP service provider has a SIP outbound server to handle voice calls. This allows the ZyXEL Device to work with any type of NAT router and eliminates the need for STUN or a SIP ALG. Turn off any SIP ALG on a NAT router in front of the ZyXEL Device to keep it from re-translating the IP address (since this is already handled by the outbound proxy server).
Outbound Proxy Address	Enter the IP address or domain name of the SIP outbound proxy server, if your VoIP service provider gave you one. You can use up to 95 printable ASCII characters.
Outbound Proxy Port	Enter the SIP outbound proxy server's listening port number, if your VoIP service provider gave you one.
Authentication	
User Name	Enter the user name for registering this SIP account, exactly as it was given to you. You can use up to 127 printable ASCII characters.
Password	Enter the password for registering this SIP account, exactly as it was given to you. You can use up to 127 printable ASCII Extended set characters.
Back	Click to return to the previous screen without saving your changes.
Apply	Click to save your changes.
Reset	Click to restore your previously saved settings.
Advanced	Click this to edit the advanced settings for this SIP account. The Advanced SIP Settings screen appears.

3.3.1 Advanced SIP Settings

To access the following screens, connect to the Web Configurator as described in steps 1-3 of [Chapter 2 on page 9](#); however, instead of clicking **Go to Wizard Setup** (as described in step 4) click **Go to Advanced Setup**.

Once you're in the advanced Web Configurator, click **Advanced in VoIP > SIP Settings** to set up and maintain advanced settings for each SIP account.

Note: Enter any advanced SIP configuration information as it was given to you by your SIP service provider. If you do not have any advanced configuration information, you can skip this section.

Figure 5 Advanced SIP Settings (part 1)

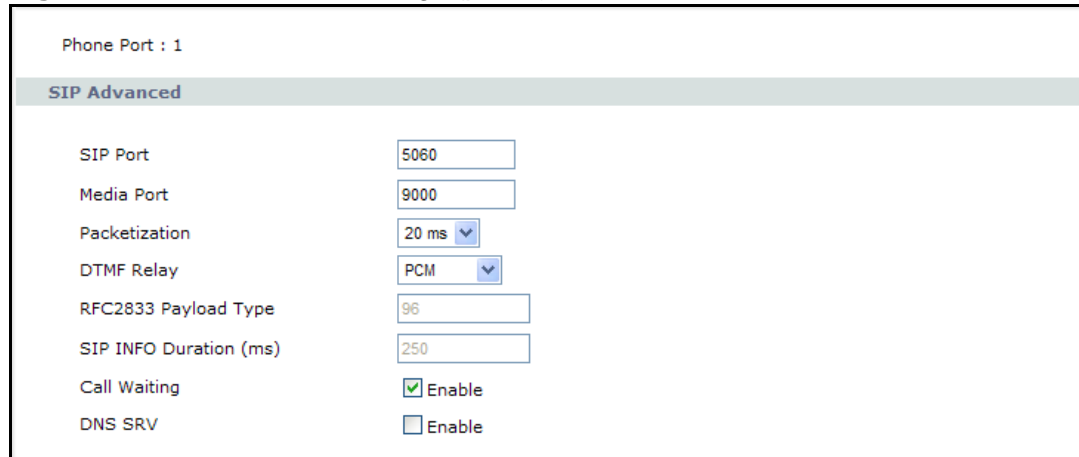

Phone Port : 1

SIP Advanced

SIP Port: 5060

Media Port: 9000

Packetization: 20 ms

DTMF Relay: PCM

RFC2833 Payload Type: 96

SIP INFO Duration (ms): 250

Call Waiting: Enable

DNS SRV: Enable

The following table describes the labels in this screen.

Table 2 SIP Setting

LABEL	DESCRIPTION
SIP Port	Enter the port number on your ZyXEL Device that SIP calls made with the selected phone should use.
Media Port	Enter the port number on your ZyXEL Device that RTP media packets should use.
Packetization	<p>Select the voice codec packetization interval in milliseconds. The default is 20 ms. This is used to minimize loss that happens during transmission of voice data over the network.</p> <p>The packetization interval effectivately sets the size of each voice sample contained within a data packet. At 20 ms, the codec employed in digitizing the voice signal can usually compensate for data degredation and attenuation by using Packet Loss Concealment (PLC). However, if the loss becomes too great, noticeable distortion occurs.</p> <p>Setting the packetization interval higher, however, may introduce more problems depending on the codec (such as G.711). Other codecs (such as G.729 and G.723) have improved PLC techniques and as such can also withstand a higher packetization interval; this means more packets can be lost in transit without a noticeable loss in quality.</p>

Table 2 SIP Setting (continued)

LABEL	DESCRIPTION
DTMF Relay	<p>Dual-Tone Multi-Frequency (DTMF) relay detects DTMF signals and sends them out-of-band (via SIP or RTP) to the remote party. DTMF relay is used when a low-bitrate voice codec might distort DTMF signals sent over the voice channel.</p> <p>The available relay types are:</p> <ul style="list-style-type: none"> • RFC2833 - Relays DTMF tones in outband RTP packets. • SIP INFO - Relays DTMF tones in outband SIP packets. • PCM - Relays DTMF tones in the voice data stream. PCM provides very good sound quality with certain codecs (such as G.711) but requires 64 kbps of bandwidth. With other codecs (such as G.729), sound distortion may occur.
RFC2833 Payload Type	<p>This defines the DTMF tone type in decimal encoding, and which allows gateways to recognize a DTMF tone that has been embedded in a voice signal and then respond accordingly.</p> <p>Enter a digit that corresponds directly to a payload event type, as defined in the RFC-2833 standard.</p>
SIP INFO Duration (ms)	Specify DTMF tone play duration in milliseconds.
Call Waiting	Select this to enable the call waiting feature, if supported by your phone or SIP service provider.
DNS SRV	Select Enable to have the ZyXEL Device query your ISP's DNS server for a list of any available SIP servers that it maintains. This is useful if your static SIP server experiences difficulties, making it hard for your IP phone users to make SIP calls.

Figure 6 Advanced SIP Settings (part 2)

Forward Setting

Immediate Forward to Off Enable
 Immediate Number
 Busy Forward to Off Enable
 Busy Number
 No Answer Forward to Off Enable
 No Answer Number
 No Answer Time (sec)

Fax Option

G.711 Fax Passthrough T.38 Fax Relay

P-Asserted-Identity

P-Asserted-Identity Enable

Dial Termination Key

Dial Termination Key Enable

The following table describes the labels in this screen.

Table 3 SIP Setting

LABEL	DESCRIPTION
Forward Setting	
Immediate Forward to	Select Enable to turn this feature on, and Off to disable it. When enabled, all incoming calls are forwarded immediately to the Immediate Number .
Immediate Number	Enter a SIP number to receive calls forwarded from the ZyXEL Device.
Busy Forward to	Select Enable to turn this feature on, and Off to disable it. When enabled, incoming calls are forwarded to the Busy Number if they receive a busy signal from the ZyXEL Device.
Busy Number	Enter a SIP number to receive calls forwarded from the ZyXEL Device.
No Answer Forward to	Select Enable to turn this feature on, and Off to disable it. When enabled, calls that receive no answer after the No Answer Time has passed are forwarded to the No Answer Number .
No Answer Number	Enter a SIP number to receive calls forwarded from the ZyXEL Device.
No Answer Time (sec)	Enter the number of seconds the ZyXEL Device waits while an incoming call goes unanswered. Once this duration has expired, the incoming calls is forwarded to the No Answer Number .
Fax Option	
G.711 Fax Passthrough	Select this if the ZyXEL Device should use G.711 to send fax messages. The peer devices must also use G.711.
T.38 Fax Relay	Select this if the ZyXEL Device should send fax messages as UDP packets through IP networks. This provides better quality, but it may have inter-operability problems. The peer devices must also use T.38.
P-Asserted-Identity	Select Enable to add a P-Asserted-Identity header field which carries the identity of the caller into SIP messages. If the ZyXEL Device does not trust the user that sent the SIP request, the ZyXEL Device must authenticate the user and then use the identity which results from the authentication to generate a P-Asserted-Identity header field.
Dial Termination Key	Select Enable if you want to use the pound key (#) to tell the ZyXEL Device to make the phone call immediately, instead of waiting the number of seconds you selected in the Interdigit Pause Duration field of the VoIP > Phone > Common screen. If you select this, dial the phone number, and then press the pound key. The ZyXEL Device makes the call immediately, instead of waiting. You can still wait, if you want.

Figure 7 Advanced SIP Settings (part 3)

Session Timer

Enable

Minimum Expiration Time (Min 90, Max 65536, Default 90) sec

Maximum Expiration Time (Min 90, Max 65536, Default 1800) sec

Dial Plan

Active

Dial Plan Rules

MWI (Message Waiting Indication)

Active

Expiration Time (1-65535) sec

DND (Do Not Disturb)

DND Mode Always Enable Disable

From : (hh:mm)

To : (hh:mm)

The following table describes the labels in this screen.

Table 4 SIP Setting

LABEL	DESCRIPTION
Session Timer	
Enable	Select Enable if you want to define how long the ZyXEL Device waits to receive a session-alive packet for a voice session from the SIP server.
Minimum Expiration Time	Enter the minimum time the ZyXEL Device waits for a session-alive packet (90-65536 seconds). If a session-alive packet is not received during this time, the voice session is terminated.
Maximum Expiration Time	Enter the maximum time the ZyXEL Device waits for a session-alive packet (90-65536 seconds). If a session-alive packet is not received during this time, the voice session is terminated.
Dial Plan	
Active	Select Active to enable the dial plan feature. A dial plan is used by a service provider to define the expected rules and digit patterns for the telephone numbers it uses. If your dial plan does not match the service provider's, you probably will not be able to connect to their servers.

Table 4 SIP Setting (continued)

LABEL	DESCRIPTION
Dial Plan Rules	<p>Enter the dial plan rules pattern.</p> <p>A rules pattern may look something like this:</p> <pre>(*xx [3469]11 [2-9]xxx 011x)</pre> <p>A dial plan defines the dialing patterns, such as the length and range of the digits for a telephone number. It also includes country codes, access codes, area codes, local numbers, long distance numbers or international call prefixes.</p> <ul style="list-style-type: none"> • The collection of rules is in parentheses (). • Rules are separated by the (bar) symbol. • "x" stands for a wildcard and can be any digit from 0 to 9. • A subset of keys is in a square bracket []. Ranges are allowed. <p>Without a dial plan, users have to manually enter the whole callee's number and wait for the specified dialing interval to time out or press a terminator key (usually the pound key on the phone keypad) before the ZyXEL Device makes the call.</p>
MWI (Message Waiting Indications)	
Active	Select this if you want to hear a waiting (beeping) dial tone on your phone when you have at least one voice message. Your SIP service provider must support this feature.
Expiration Time	Keep the default value, unless your SIP service provider tells you to change it. Enter the number of seconds the SIP server should provide the message waiting service each time the ZyXEL Device subscribes to the service. Before this time passes, the ZyXEL Device automatically subscribes again.
DND (Do Not Disturb)	
DND Mode	<p>Select Enable to activate the Do Not Disturb feature during the time period specified in the From and To fields.</p> <p>Select Always to activate the Do Not Disturb feature all the time.</p> <p>Select Disable to deactivate the Do Not Disturb feature altogether.</p>
From	Enter the start hour and minutes for DND mode to be activated when the Enable option is selected.
To	Enter the end hour and minutes for DND mode to be deactivated when the Enable option is selected.

Figure 8 Advanced SIP Settings (part 4)

Codec Setting										
Type	Priority								Mode	
	1	2	3	4	5	6	7	8		
G711-ulaw	<input checked="" type="checkbox"/>	<input type="checkbox"/>	<input type="checkbox"/>	<input type="checkbox"/>	<input type="checkbox"/>	<input type="checkbox"/>	<input type="checkbox"/>	<input type="checkbox"/>	<input type="checkbox"/>	
G711-alaw	<input type="checkbox"/>	<input checked="" type="checkbox"/>	<input type="checkbox"/>	<input type="checkbox"/>	<input type="checkbox"/>	<input type="checkbox"/>	<input type="checkbox"/>	<input type="checkbox"/>	<input type="checkbox"/>	
G729	<input type="checkbox"/>	<input type="checkbox"/>	<input checked="" type="checkbox"/>	<input type="checkbox"/>	<input type="checkbox"/>	<input type="checkbox"/>	<input type="checkbox"/>	<input type="checkbox"/>	<input type="checkbox"/>	
G723	<input type="checkbox"/>	<input type="checkbox"/>	<input type="checkbox"/>	<input checked="" type="checkbox"/>	<input type="checkbox"/>	<input type="checkbox"/>	<input type="checkbox"/>	<input type="checkbox"/>	<input type="checkbox"/>	5.3k ▾
G726-16k	<input type="checkbox"/>	<input type="checkbox"/>	<input type="checkbox"/>	<input type="checkbox"/>	<input checked="" type="checkbox"/>	<input type="checkbox"/>	<input type="checkbox"/>	<input type="checkbox"/>	<input type="checkbox"/>	
G726-24k	<input type="checkbox"/>	<input type="checkbox"/>	<input type="checkbox"/>	<input type="checkbox"/>	<input type="checkbox"/>	<input checked="" type="checkbox"/>	<input type="checkbox"/>	<input type="checkbox"/>	<input type="checkbox"/>	
G726-32k	<input type="checkbox"/>	<input type="checkbox"/>	<input type="checkbox"/>	<input type="checkbox"/>	<input type="checkbox"/>	<input type="checkbox"/>	<input checked="" type="checkbox"/>	<input type="checkbox"/>	<input type="checkbox"/>	
G726-40k	<input type="checkbox"/>	<input type="checkbox"/>	<input type="checkbox"/>	<input type="checkbox"/>	<input type="checkbox"/>	<input type="checkbox"/>	<input type="checkbox"/>	<input checked="" type="checkbox"/>	<input type="checkbox"/>	

The following table describes the labels in this screen.

Table 5 SIP Setting

LABEL	DESCRIPTION
Codec Setting	
Type	This lists the available voice codecs.
Priority	Use this section to indicate the codec priority. Codecs are engaged in order of priority from 1 to 8, with 1 being the highest on the list. The ZyXEL Device cycles through the codecs until it finds one that matches the device of the other party in the telephone conversation. If the ZyXEL Device does not have any codecs in common with the other device then the call is dropped.
Mode	Select a pulse code modulation for the G.723 codec.
Back	Click this to return to the previous screen with saving your changes.
Apply	Click this to save your changes and then return to the previous screen.
Reset	Click this to reset the options in this screen to their last saved settings.

3.4 Speed Dial Settings

Click **VoIP > Phone Book > Speed Dial** to open this screen. This is where you can store pre-configured telephone numbers as speed dial numbers.

When you press a speed dial number on your phone, the telephone number is dialed automatically. For example, if you configure speed dial number '#01' with

the telephone number for local information, '411', then when you press #01 on your phone's keypad and wait 3 seconds, the ZyXEL Device dials 4-1-1.

Figure 9 The Speed Dial Screen

Position	Name	Phone Number	Select
#01			<input type="checkbox"/>
#02			<input type="checkbox"/>
#03			<input type="checkbox"/>
#04			<input type="checkbox"/>
#05			<input type="checkbox"/>
#06			<input type="checkbox"/>
#07			<input type="checkbox"/>
#08			<input type="checkbox"/>
#09			<input type="checkbox"/>
#10			<input type="checkbox"/>

Remove Selected Remove All

Apply Reset

The following table describes the labels in this screen.

Table 6 Speed Dial

LABEL	DESCRIPTION
Port Setting (P-2702R only)	Select the phone port you want to configure in this screen.
Position	This indicates the speed dial number.
Name	Enter a name to associate with this speed dial number (such as "Information" or "Emergency").
Phone Number	Enter a phone number to associate with this speed dial number.
Select	Check this to select the speed dial number so it can be removed.
Remove Selected	Click this to clear the settings for the selected speed dial number(s).
Remove All	Click this to clear the settings for all speed dial numbers.
Back	Click this to return to the previous screen with saving your changes.
Apply	Click this to save your changes and then return to the previous screen.
Reset	Click this to reset the options in this screen to their defaults.

3.5 Dial Plan with URL

Click **VoIP > Phone Book > Dial Plan with URL** to open this screen. Use this screen to create dial plan with URL entries which allow you to make peer-to-peer calls. In peer-to-peer calls, you call another VoIP device directly without going through a VoIP service provider's SIP server. Enter the callee's IP address or domain name. The ZyXEL Device sends SIP INVITE requests to the specified peer VoIP device when you dial the SIP number configured in this screen.

Figure 10 Dial Plan with URL

Port Setting : Phone 1

Dial Plan with URL

Index	SIP Number	Destination	Active (Enable)
1			<input type="checkbox"/>
2			<input type="checkbox"/>
3			<input type="checkbox"/>
4			<input type="checkbox"/>
5			<input type="checkbox"/>
6			<input type="checkbox"/>
7			<input type="checkbox"/>
8			<input type="checkbox"/>
9			<input type="checkbox"/>
10			<input type="checkbox"/>
11			<input type="checkbox"/>
12			<input type="checkbox"/>
13			<input type="checkbox"/>
14			<input type="checkbox"/>
15			<input type="checkbox"/>
16			<input type="checkbox"/>
17			<input type="checkbox"/>
18			<input type="checkbox"/>
19			<input type="checkbox"/>
20			<input type="checkbox"/>

Remove Selected Remove All [^] [v] (* means any)

Apply Reset

The following table describes the labels in this screen.

Table 7 Dial Plan with URL

LABEL	DESCRIPTION
Index	This indicates the index number of each entry.
Port Setting (P-2702R only)	Select the phone port you want to configure here.
SIP Number	Enter the SIP number you want the ZyXEL Device to call.
Destination	Enter the IP address or domain name of the party you want to call when you dial the corresponding SIP number to make a peer-to-peer call.
Active	Check this to select an entry so it can be enabled, removed or moved up/down.
Remove Selected	Click this to clear the settings for the selected entry(ies).
Remove All	Click this to clear the settings for all entries.
	Click the icon to change the position of an entry in the list.
Apply	Click this to save your changes and then return to the previous screen.
Reset	Click this to reset the options in this screen to their defaults.

3.6 Supported Phone Functions

The following table shows the key combinations you can enter on your phone's keypad to use certain features after you pick up the phone's receiver.

Note: After pressing the flash key, if you do not issue the sub-command before the default sub-command timeout (2 seconds) expires or issue an invalid sub-command, the current operation will be aborted.

Note: If the flash key is not available, you can tap (press and immediately release) the hook by hand to achieve the same effect.

Table 8 Call Features

FUNCTION	KEY COMBINATIONS	USA	EUROPE (DEFAULT)
Call-Hold / Call-Retrieve	FLASH	<ol style="list-style-type: none"> Put the current call on hold and create a dial tone. Switch back and forth between two calls. 	<ol style="list-style-type: none"> Put the current call on hold and create a dial tone. Switch back to the first call (if there is no second call).
	FLASH 0		Drop a call previously put on hold.
	FLASH 1		Drop the current call and resume a call previously put on hold.

Table 8 Call Features (continued)

FUNCTION	KEY COMBINATIONS	USA	EUROPE (DEFAULT)
	FLASH 2		Switch back and forth between two calls.
Call-Waiting	FLASH	Put the current call on hold to answer an incoming call.	
	FLASH 0		Reject an incoming call which is waiting for an answer.
	FLASH 1		Drop the current call and answer the incoming call.
	FLASH 2		Put the current call on hold to answer an incoming call.
3-way Calling	FLASH	Put a current call on hold to place a second call. After the second call is successful, press the flash key again to have a three-way conference call.	
	FLASH 2		<ol style="list-style-type: none"> 1. Separate the current three-way conference call into two individual calls (one is on-line, the other is on hold). 2. Switch back and forth between two calls.
	FLASH 3		Put a current call on hold in order to make a second call by pressing the flash key. When the second call is answered, press the flash key and then 3 to create a three-way conversation.
Blind Transfer	FLASH *98#	<p>Do the following to transfer an incoming call (that you have answered) to another phone.</p> <ol style="list-style-type: none"> 1. Press the flash key to put the caller on hold. 2. When you hear the dial tone, dial *98# followed by the number to which you want to transfer the call. 3. After you hear a busy tone, hang up the phone. 	
Consult-On-Hold Transfer	FLASH *98#	<p>Do the following to transfer an incoming call (that you have answered) to another phone.</p> <ol style="list-style-type: none"> 1. Press the flash key to put the caller on hold. 2. When you hear the dial tone, dial the number to which you want to transfer the call. 3. When the second call is answered, press the flash key and *98#, then hang up the phone. 	

Table 8 Call Features (continued)

FUNCTION	KEY COMBINATIONS	USA	EUROPE (DEFAULT)
Internal Call	# # # #	Call the phone(s) connected to the ZyXEL Device's other phone port.	
Speed dial	#01 ~ #10	Press a speed dial number on your phone to have the ZyXEL Device automatically dial the pre-configured telephone number. See Section 3.4 on page 24 for more information.	
IVR Main Menu	#120	Tell you the ZyXEL Device's WAN IP address.	
	#121	Tell you the ZyXEL Device's IP type.	
	#123	Tell you the ZyXEL Device's subnet mask.	
	#124	Tell you the ZyXEL Device's gateway address.	
	#125	Tell you the ZyXEL Device's DNS server address(s).	
	#126	Tell you the ZyXEL Device's LAN IP address.	
	#128	Tell you the ZyXEL Device's current firmware version.	

Maintenance

This chapter shows you how to configure system related settings, such as operating mode and system password, and auto-provision and TR-069 auto-configuration settings.

4.1 System Mode and Accounts

Use this screen to configure your ZyXEL Device as a router or a bridge, and the system passwords.

4.1.1 Operating Mode

The ZyXEL Device is in router mode by default and functions as a router.

In bridge mode, the DHCP server on the ZyXEL Device is disabled. If you connect your computer directly to the ZyXEL Device, you need to assign your computer a static IP address in the same subnet as the ZyXEL Device's IP address in order to access the ZyXEL Device. You can configure the ZyXEL Device's IP address in order to access the ZyXEL Device in bridge mode for management.

You can NOT use the firewall, content filtering or NAT in bridge mode.

4.1.2 System Accounts

The ZyXEL Device provides two account types (administrator and user) with different privilege levels. The web configurator screens vary depending on which account you use to log in.

The administrator account allows you to do all settings on the ZyXEL Device. With the user account, you can view the status page, configure the WAN, LAN, NAT, firewall and content filtering settings, modify the user account password and auto-provision server address, change operating mode and system time, do firmware upgrade and view system logs.

Click **Maintenance > System > General** to open this screen.

Figure 11 System General

The following table describes the labels in this screen.

Table 9 System General

LABEL	DESCRIPTION
System Setup	
Mode	Select Router to set the ZyXEL Device to router mode. Select Bridge and configure the Manager IP Address to set the ZyXEL Device to bridge mode.
Administrator Inactivity Timer	Type how many minutes a management session (either via the web configurator or telnet) can be left idle before the session times out. The default is 5 minutes. After it times out you have to log in with your password again. Very long idle timeouts may have security risks. A value of "0" means a management session never times out, no matter how long it has been left idle (not recommended).
Manager IP Address	Enter the management IP address of the ZyXEL Device if it is in bridge mode.
Administrator/User Account	
User Name	Type the user name you use to access the system.
User Password	Type your new system password (up to 30 characters). Note that as you type a password, the screen displays a dot for each character you type. After you change the password, use the new password to access the ZyXEL Device.
Apply	Click this to save your changes and then return to the previous screen.
Reset	Click this to reset the options in this screen to their defaults.

4.2 Auto-Provision

Click **Maintenance > System > Auto Provision** to open this screen. If you need to provision more than one ZyXEL Device, use this screen to back up (save) the ZyXEL Device's current configuration to a text file on your computer. Edit the configuration file using a text editor and put it on an auto-provisioning server. Then configure the ZyXEL Device to download the configuration file (and firmware) automatically from the auto-provisioning server, meaning you do not have to upload them manually.

Figure 12 Auto Provision

The following table describes the labels in this screen.

Table 10 Auto Provision

LABEL	DESCRIPTION
Backup Auto-provision File	
Backup	Click Backup to save the ZyXEL Device's auto-provisioning configuration file to your computer.
Auto Provision	
Protocol	Select the networking protocol (HTTP , TFTP or FTP) you want to use to access the auto-provisioning server to download the configuration file. Otherwise, select Disable to not request and receive auto-provisioning files.
HTTP/TFTP/FTP Server Address	Enter the auto-provisioning server IP address.
HTTP Server Port	If you select to transmit the auto-provisioning configuration file using HTTP, enter the server's port number.
FTP Username	If you select to transmit the auto-provisioning configuration file using FTP, enter your FTP account user name for authentication.

Table 10 Auto Provision (continued)

LABEL	DESCRIPTION
FTP Password	If you select to transmit the auto-provisioning configuration file using FTP, enter your FTP account password for authentication.
File Path	Specify the location of the auto-provisioning file you want to download.
Expiration Time	Specify how long the ZyXEL Device waits after it successfully receives an auto-provisioning file before it requests another.
Apply	Click this to save your changes and then return to the previous screen.
Reset	Click this to reset the options in this screen to their defaults.

4.3 TR-069 Setting

TR-069 defines how Customer Premise Equipment (CPE), for example your ZyXEL Device, can be managed over the WAN by an Auto Configuration Server (ACS). TR-069 is based on sending Remote Procedure Calls (RPCs) between an ACS and a client device. RPCs are sent in Extensible Markup Language (XML) format over HTTP or HTTPS.

An administrator can use an ACS to remotely set up the ZyXEL Device, modify settings, perform firmware upgrades as well as monitor and diagnose the ZyXEL Device. You have to enable the device to be managed by the ACS and specify the ACS IP address or domain name and username and password.

Click **Maintenance > System > TR069 Setting** to open this screen. Use this screen to configure your ZyXEL Device to be managed by an ACS.

Figure 13 TR069 Setting

The following table describes the labels in this screen.

Table 11 TR069 Setting

LABEL	DESCRIPTION
General	
ACS Client Enable	Select Enabled to activate remote management via TR-069 on the WAN. Otherwise, select Disabled .
ACS URL	Enter the URL or IP address of the auto-configuration server.
User Name	Enter the TR-069 user name for authentication with the auto-configuration server.
Password	Enter the TR-069 password for authentication with the auto-configuration server.
Periodic Inform Enable	Select Enabled to set the periodic inform time interval. Otherwise, select Disabled .
Periodic Inform Interval	Enter the time interval (in seconds) at which the ZyXEL Device sends information to the auto-configuration server.
Connection Request	
User Name	Enter the connection request user name. When the ACS makes a connection request to the ZyXEL Device, this user name is used to authenticate the ACS.

Table 11 TR069 Setting (continued)

LABEL	DESCRIPTION
Password	Enter the connection request password. When the ACS makes a connection request to the ZyXEL Device, this password is used to authenticate the ACS.
Apply Changes	Click this to save your changes and then return to the previous screen.
Reset	Click this to reset the options in this screen to their defaults.

Troubleshooting

This chapter offers some suggestions to solve problems you might encounter.

None of the lights turn on when I plug in the ZyXEL Device.

- Make sure that you are using the power adaptor provided with the ZyXEL Device.
- Check all the hardware connections.
- Make sure the power source is turned on.
- If the problem continues, contact your vendor.

The **POWER** light is red.

- Unplug the device, and plug it in again.
- If the problem continues, contact your vendor.

I can open the web browser, but I cannot see the **Login** screen.

- Make sure your web browser meets the requirements identified in section 1.3.
- Check the connection between your computer and the ZyXEL Device. See section 1.4.
- If the ZyXEL Device is configured to work as a DHCP server for LANs, ensure that your computer is set up to receive an IP address automatically (consult your operating system's help to determine how to do this if you do not know).
- Make sure your computer's Ethernet adapter is installed and functioning properly.
- If you changed the IP address, make sure you use the new IP address in the **Address** or **URL** field in the web browser.
- If the problem continues, contact your local vendor.

My password is not working.
or
I forgot my password for the ZyXEL Device.

- Make sure you enter the password correctly. It is case-sensitive.
- If you changed the password and then forgot it, you can reset the device pressing down the ZyXEL Device's **Reset** button and holding it for 3 seconds.

The web configurator returns to the **Login** screen when I try to do something.

By default, the Web Configurator times out after five minutes and you must log in again.

When I pick up the phone's receiver, I hear no dial tone.

Makes sure that your telephone and the ZyXEL Device are properly connected.

Test the telephone wire:

- 1 Connect the wire to a telephone and a regular telephone outlet.
- 2 If you cannot hear the dial tone, the wire might be broken. Use a different one.
If the problem continues, contact your local vendor.

I cannot make VoIP phone calls.
or
The dial tone beeps or pulses.

- Log in to the ZyXEL Device. On the **Status** page, consult the **VoIP Status** section at the bottom to see if at least one VoIP account is registered. If not, click **Register** for the VoIP account(s) in question.
- If the problem continues, contact your vendor.

5.0.1 Resetting the ZyXEL Device

This changes all the ZyXEL Device's settings to their original values. You will need to configure any custom settings again.

Note: Make a note of your custom settings before you reset the ZyXEL Device.

To reset the ZyXEL Device:

- 1 Press the **RESET** button until the **POWER**, **PHONE 1**, and **PHONE 2/Lifeline** lights starts to blink in sequence. (This usually takes ten seconds or less.)
- 2 Release the **RESET** button.

5.0.2 REG Status List

REG Status allows you to see your SIP connection's current status. This can be useful in diagnosing connection problems or troubleshooting why a call cannot go through. **REG Status** information appears in two places: in the **Connection Wizard**, after you finish setting up your VoIP connections:

Figure 14 The Connection Wizard

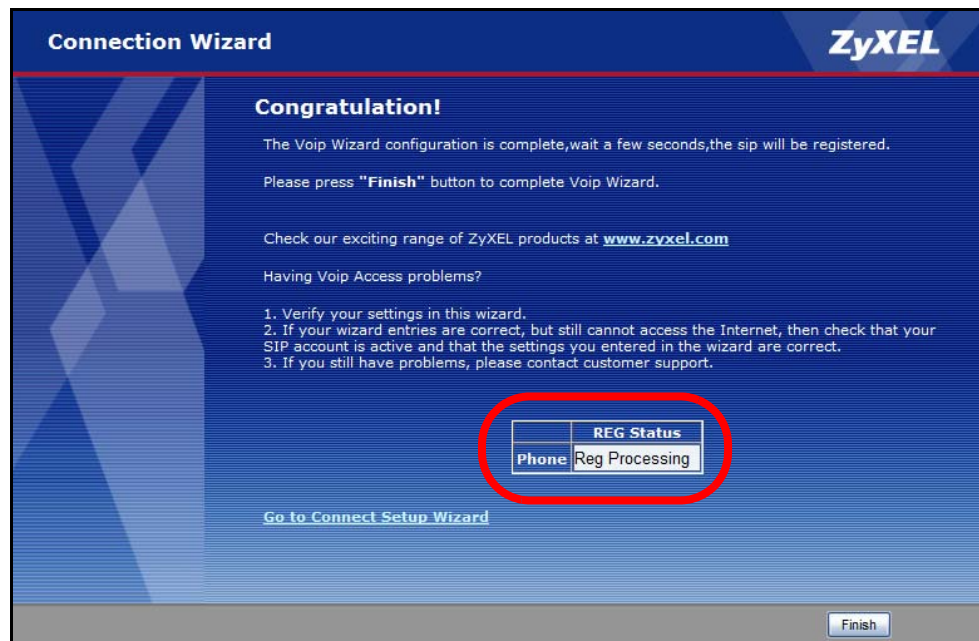

And in the Web Configurator's main **Status** screen under **VoIP Status**:

Figure 15 The Status Screen

The screenshot shows the ZyXEL Web Configurator interface. The left sidebar contains navigation options: Status, Network, VoIP, Security, and Maintenance. The main content area is titled 'Status' and includes several sections: Device Information, System Status, WAN Information, LAN Information, Interface Status, and Summary Status. The 'VoIP Status' section at the bottom is circled in red and contains the following table:

SIP Account	Registration	REG Status	URI
Phone 1	Register	Reg Processing	

Use the following table to determine your phone's REG status:

Table 12 REG Status

CODE	STATUS
380	Alternative Service response
400	Bad Request response
401	Unauthorized response
402	Payment Required response
403	Forbidden response
404	Not Found response
405	Method Not Allowed response
407	Proxy AuthenticationRequired response
408	Request Timeout response
410	Gone response
411	Length Required response
413	Request Entity Too Large response
414	Request-URI Too Long response
415	Unsupported Media Type response
416	Unsupported URI Scheme response
420	Bad Extension response

Table 12 REG Status

CODE	STATUS
421	Extension Required response
422	Session Timer IntervalToo Small response
423	Interval Too Brief response
428	Use Authentication Token response
429	Provide Referror Identity response
480	Temporarily Unavailable response
481	Dialog/Transaction Does Not Exist response
482	Loop Detected response
483	Too Many Hops response
484	Address Incomplete response
485	Ambiguous response
486	Busy Here response
487	Request Terminated response
488	Not Acceptable Here response
489	Bad Event response
491	Request Pending response
493	Request Undecipherable response
501	Not Implemented response
502	Bad Gateway response
503	Service Unavailable response
504	Gateway Timeout response
505	Version Not Supported response
513	Message Too Large response
600	Busy Everywhere response
603	Decline response
604	Does Not Exist Anywhere response
606	Not Acceptable response

Specifications

Specifications are accurate at the time of writing.

FEATURE	SPECIFICATION
Default IP address	192.168.1.1
Default subnet mask	255.255.255.0
Default Admin User Name	admin
Default Admin Password	1234
Default User Name	user
Default User Password	user
Dimensions (mm)	98 (Wide) x 82 (Deep) x 28 (High)
Distance between the wall-mounting holes on the device's back	77 mm
Screw size for wall-mounting	M3 tap screw
Weight	110 g
Ethernet ports	Two RJ-45, 10/100Mbps Half / Full Auto-negotiation, Auto-crossover Ethernet ports
Phone ports	P-2701RL: One FXS (Foreign eXchange Station) POTS port. P-2702R: Two FXS (Foreign eXchange Station) POTS ports.
Feeding Voltage	On hook: -48V; Minimum Voltage: -20V Off hook: -24V
Ring Voltage	P-2702R: 40V RMS at 5 REN P-2701RL: 40V RMS at 3 REN
Line Ports (P-2701RL Only)	One FXO (Foreign eXchange Office) PSTN line port
Operation Temperature	0° C ~ 40° C
Storage Temperature	-30° ~ 70° C
Operation Humidity	20% ~ 90% RH
Storage Humidity	20% ~ 95% RH

6.1 Features

FEATURE	DESCRIPTION
WAN Interface	DHCP (Static IP/Dynamic IP) PPPoE (Dynamic IP) PPTP
LAN Interface	DHCP (Server/Disable)
Voice Functions	SIP version 2 (RFC 3261) DNS SRV (RFC 2782) SDP (RFC 2327) SIP INFO (RFC 2976) STUN (RFC 3489) RTP (RFC 3550) RTCP (RFC 3551) SIP Session Timers (RFC 4028) Reliability of Provisional Response in SIP (RFC 3262) Locating SIP Servers (RFC 3263) An Offer/Answer Model with the Session Description Protocol (RFC 3264) SIP-Specific Event Notification (RFC 3265) SIP UPDATE method (RFC 3311) SIP REFER method (RFC 3515) Flexible Dial Plan (RFC3525 section 7.1.14) Early Media and Ringing Tone Generation (RFC 3960) Message Waiting Indicator (RFC 3842)

FEATURE	DESCRIPTION
Protocol Support	TCP / IP UDP / IP DNS ICMP TELNET TFTP FTP HTTP NTP ARP Dynamic DNS RIP-1(RFC 1058), RIP-2(RFC1389)
Security	IP Filtering MAC Filtering URL Filtering Port Filtering Port Forwarding DMZ MD5 encryption
Supervision and Control	Two Tier WEB Interfaces Telnet Firmware Upgrade via FTP or TFTP or HTTP Backup and Restore Configuration Proprietary Auto-Provision Traffic Statistics Reset to Default Web Access Account Configuration Time Zone Configuration
NAT	SUA (Many to One) Port Forwarding NAT Concurrent 1024 sessions
QoS	SIP/RTP TOS & DiffServ Marking VLAN Tagging

FEATURE	DESCRIPTION
Audio Codec	ITU-T G.711 (64 Kbps) ITU-T G.729 AB ITU-T G.726 (16/24/32/40 kbps) ITU-T G.723.1 (6.3K/5.3Kbps) Detection and Suppression of Silence (VAD) Comfort Noise Generation of (Comfort Noise) Echo Cancellation: G.168/G.165 Volume Adjustment Dynamic Jitter Buffer (Adaptive) PLC (Packet Loss Concealment) DTMF Detection and Generation DTMF: In-Band and Out-of-Band (PCM, RFC 2833, SIP INFO) G.711 PCM Fax, Modem Detection and Pass-through Duration of hook flash is adjustable Different Country Tone Table 1. Dial Tone 2. Busy Tone 3. Congestion Tone 4. Ring back Tone 5. Call Waiting Tone 6. Howler Tone
LED Indicators	LAN WAN POWER PHONE 1 PHONE 2

6.2 Wall Mounting Instructions

To hang your ZyXEL Device on a wall:

- 1 Select a position free of obstructions on a sturdy wall.
- 2 Drill two holes for the screws. Make sure the distance between the centers of the holes and the size of screws match the following specifications:

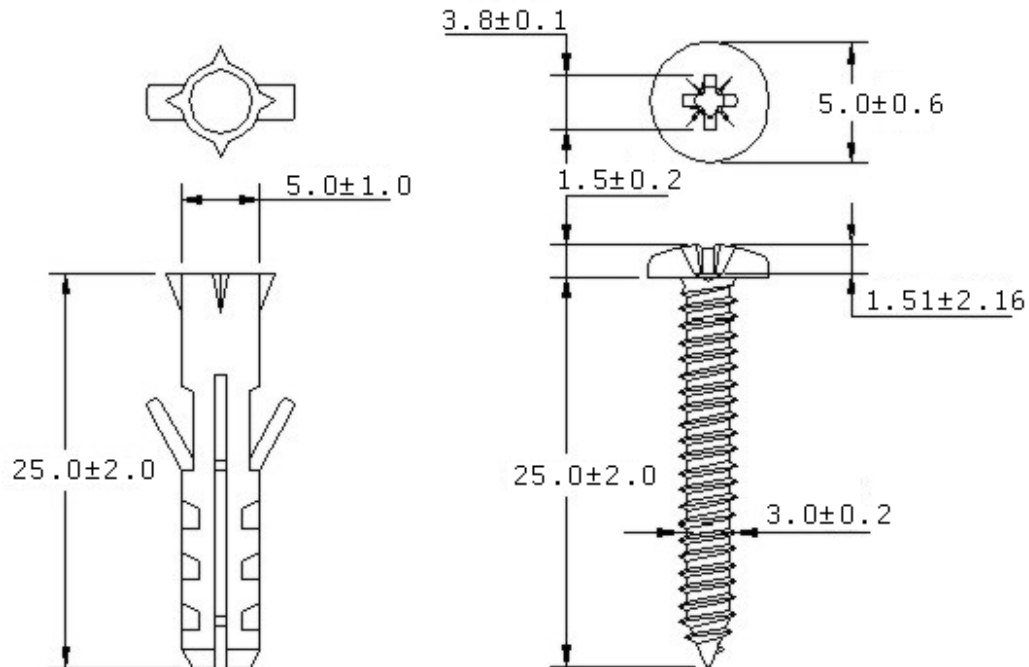

Note: Be careful to avoid damaging pipes or cables located inside the wall when drilling holes for the screws.

- 3 Do not screw the screws all the way into the wall. Leave a small gap of about 0.5 cm between the heads of the screws and the wall.
- 4 Make sure the screws are snugly fastened to the wall. They need to hold the weight of the ZyXEL Device with the connection cables.
- 5 Align the holes on the back of the ZyXEL Device with the screws on the wall. Hang the ZyXEL Device on the screws.

- 5a** For a horizontal installation, do not place the device in an inverted position; make sure the holes on the back of the ZyXEL Device are positioned at the top and that they match the positions of the holes drilled into the wall. Ensure that the two side vents remain unblocked.

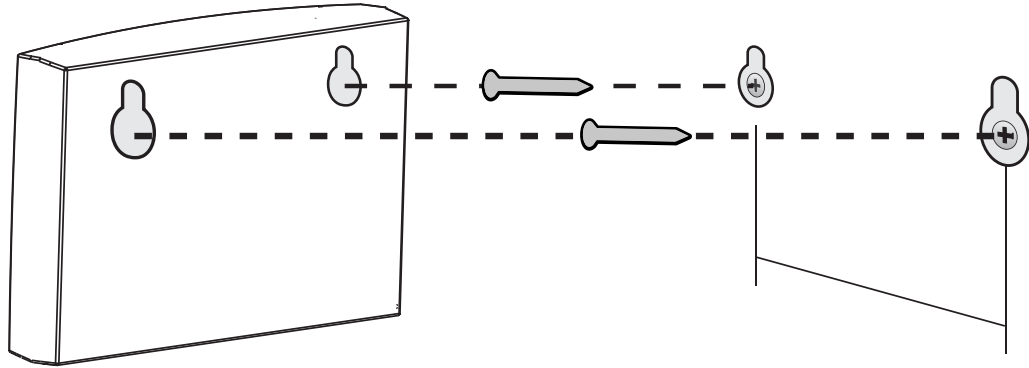

- 5b** For a vertical installation, ensure that the holes on the ZyXEL Device match the positions of the holes drilled into the wall and that the two side vents remain unblocked.

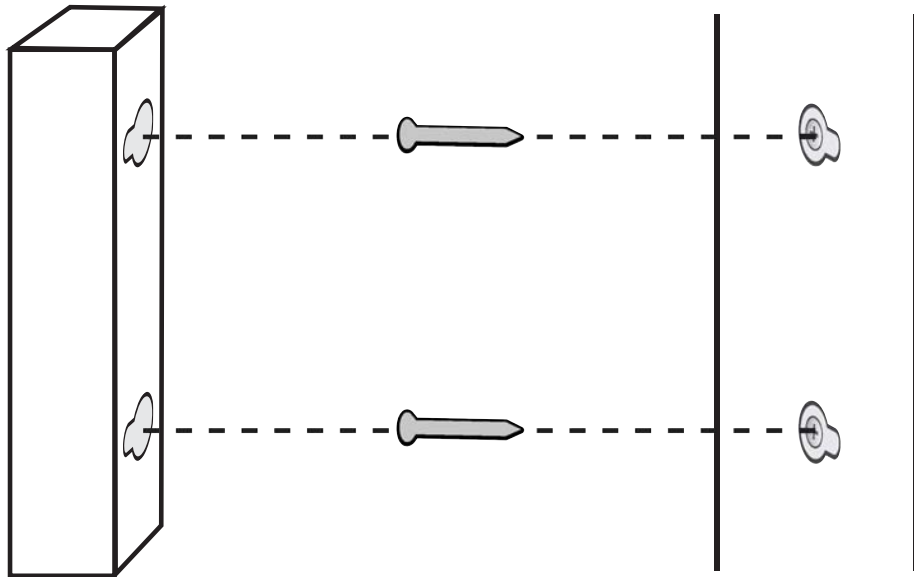

Appendix

Safety Warnings

- Do NOT use this product near water, for example, in a wet basement or near a swimming pool.
- Do NOT expose your device to dampness, dust or corrosive liquids.
- Do NOT store things on the device.
- Do NOT install, use, or service this device during a thunderstorm. There is a remote risk of electric shock from lightning.
- Connect ONLY suitable accessories to the device.
- Do NOT open the device or unit. Opening or removing covers can expose you to dangerous high voltage points or other risks. ONLY qualified service personnel should service or disassemble this device. Please contact your vendor for further information.
- Make sure to connect the cables to the correct ports.
- Place connecting cables carefully so that no one will step on them or stumble over them.
- Always disconnect all cables from this device before servicing or disassembling.
- Use ONLY an appropriate power adaptor or cord for your device. Connect it to the right supply voltage (for example, 110V AC in North America or 230V AC in Europe).
- Do NOT allow anything to rest on the power adaptor or cord and do NOT place the product where anyone can walk on the power adaptor or cord.
- Do NOT use the device if the power adaptor or cord is damaged as it might cause electrocution.
- If the power adaptor or cord is damaged, remove it from the device and the power source.
- Do NOT attempt to repair the power adaptor or cord. Contact your local vendor to order a new one.
- Do not use the device outside, and make sure all the connections are indoors. There is a remote risk of electric shock from lightning.
- Do NOT obstruct the device ventilation slots, as insufficient airflow may harm your device.
- Use only No. 26 AWG (American Wire Gauge) or larger telecommunication line cord.
- If you wall mount your device, make sure that no electrical lines, gas or water pipes will be damaged.

This product is recyclable. Dispose of it properly.

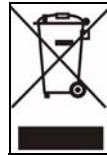

Open Software Announcements

End-User License Agreement for “P-27xx Series”

WARNING: ZyXEL Communications Corp. IS WILLING TO LICENSE THE ENCLOSED SOFTWARE TO YOU ONLY UPON THE CONDITION THAT YOU ACCEPT ALL OF THE TERMS CONTAINED IN THIS LICENSE AGREEMENT. PLEASE READ THE TERMS CAREFULLY BEFORE COMPLETING THE INSTALLATION PROCESS AS INSTALLING THE SOFTWARE WILL INDICATE YOUR ASSENT TO THEM. IF YOU DO NOT AGREE TO THESE TERMS, THEN ZyXEL, INC. IS UNWILLING TO LICENSE THE SOFTWARE TO YOU, IN WHICH EVENT YOU SHOULD RETURN THE UNINSTALLED SOFTWARE AND PACKAGING TO THE PLACE FROM WHICH IT WAS ACQUIRED, AND YOUR MONEY WILL BE REFUNDED.

1. Grant of License for Personal Use

ZyXEL Communications Corp. ("ZyXEL") grants you a non-exclusive, non-sublicense, non-transferable license to use the program with which this license is distributed (the "Software"), including any documentation files accompanying the Software ("Documentation"), for internal business use only, for up to the number of users specified in sales order and invoice. You have the right to make one backup copy of the Software and Documentation solely for archival, back-up or disaster recovery purposes. You shall not exceed the scope of the license granted hereunder. Any rights not expressly granted by ZyXEL to you are reserved by ZyXEL, and all implied licenses are disclaimed.

2. Ownership

You have no ownership rights in the Software. Rather, you have a license to use the Software as long as this License Agreement remains in full force and effect. Ownership of the Software, Documentation and all intellectual property rights therein shall remain at all times with ZyXEL. Any other use of the Software by any other entity is strictly forbidden and is a violation of this License Agreement.

3. Copyright

The Software and Documentation contain material that is protected by United States Copyright Law and trade secret law, and by international treaty provisions. All rights not granted to you herein are expressly reserved by ZyXEL. You may not remove any proprietary notice of ZyXEL or any of its licensors from any copy of the Software or Documentation.

4. Restrictions

You may not publish, display, disclose, sell, rent, lease, modify, store, loan, distribute, or create derivative works of the Software, or any part thereof. You may not assign, sublicense, convey or otherwise transfer, pledge as security or otherwise encumber the rights and licenses granted hereunder with respect to the Software. Certain components of the Software, and third party open source programs included with the Software, have been or may be made available by ZyXEL on its Open Source web site ([ftp://opensource.zyxel.com](http://opensource.zyxel.com)) (collectively the "Open-Sourced Components") You may modify or replace only these Open-Sourced Components; provided that you comply with the terms of this License and any applicable licensing terms governing use of the Open-Sourced Components. ZyXEL is not obligated to provide any maintenance, technical or other support for the resultant modified Software. You may not copy, reverse engineer, decompile, reverse compile, translate, adapt, or disassemble the Software, or any part thereof, nor shall you attempt to create the source code from the object code for the Software. Except as and only to the extent expressly permitted in this License, by applicable licensing terms governing use of the Open-Sourced Components, or by applicable law, you may not market, co-brand, private label or otherwise permit third parties to link to the Software, or any part thereof. You may not use the Software, or any part thereof, in the operation of a service bureau or for the benefit of any other person or entity. You may not cause, assist or permit any third party to do any of the foregoing. Portions of the Software utilize or include third party software and other copyright material. Acknowledgements, licensing terms and disclaimers for such material are contained in the online electronic documentation for the Software ([ftp://opensource.zyxel.com](http://opensource.zyxel.com)), and your use of such material is governed by their respective terms. ZyXEL has provided, as part of the Software package, access to certain third party software as a convenience. To the extent that the Software contains third party software, ZyXEL has no express or implied obligation to provide any technical or other support for such software. Please contact the appropriate software vendor or manufacturer directly for technical support and customer service related to its software and products.

5. Confidentiality

You acknowledge that the Software contains proprietary trade secrets of ZyXEL and you hereby agree to maintain the confidentiality of the Software using at least as great a degree of care as you use to maintain the confidentiality of your own most confidential information. You agree to reasonably communicate the terms and conditions of this License Agreement to those persons employed by you who come into contact with the Software, and to use reasonable best efforts to ensure their compliance with such terms and conditions, including, without limitation, not knowingly permitting such persons to use any portion of the Software for the purpose of deriving the source code of the Software.

6. No Warranty

THE SOFTWARE IS PROVIDED "AS IS." TO THE MAXIMUM EXTENT PERMITTED BY LAW, ZyXEL DISCLAIMS ALL WARRANTIES OF ANY KIND, EITHER EXPRESSED OR IMPLIED, INCLUDING, WITHOUT LIMITATION, IMPLIED WARRANTIES OF MERCHANTABILITY AND FITNESS FOR A PARTICULAR PURPOSE. ZyXEL DOES NOT WARRANT THAT THE FUNCTIONS CONTAINED IN THE SOFTWARE WILL MEET ANY REQUIREMENTS OR NEEDS YOU MAY HAVE, OR THAT THE SOFTWARE WILL OPERATE ERROR FREE, OR IN AN UNINTERRUPTED FASHION, OR THAT ANY DEFECTS OR ERRORS IN THE SOFTWARE WILL BE CORRECTED, OR THAT THE SOFTWARE IS COMPATIBLE WITH ANY PARTICULAR PLATFORM. SOME JURISDICTIONS DO NOT ALLOW THE WAIVER OR EXCLUSION OF IMPLIED WARRANTIES SO THEY MAY NOT APPLY TO YOU. IF THIS EXCLUSION IS HELD TO BE UNENFORCEABLE BY A COURT OF COMPETENT JURISDICTION, THEN ALL EXPRESS AND IMPLIED WARRANTIES SHALL BE LIMITED IN DURATION TO A PERIOD OF THIRTY (30) DAYS FROM THE DATE OF PURCHASE OF THE SOFTWARE, AND NO WARRANTIES SHALL APPLY AFTER THAT PERIOD.

7. Limitation of Liability

IN NO EVENT WILL ZyXEL BE LIABLE TO YOU OR ANY THIRD PARTY FOR ANY INCIDENTAL OR CONSEQUENTIAL DAMAGES (INCLUDING, WITHOUT LIMITATION, INDIRECT, SPECIAL, PUNITIVE, OR EXEMPLARY DAMAGES FOR LOSS OF BUSINESS, LOSS OF PROFITS, BUSINESS INTERRUPTION, OR LOSS OF BUSINESS INFORMATION) ARISING OUT OF THE USE OF OR INABILITY TO USE THE PROGRAM, OR FOR ANY CLAIM BY ANY OTHER PARTY, EVEN IF ZyXEL HAS BEEN ADVISED OF THE POSSIBILITY OF SUCH DAMAGES. ZyXEL'S AGGREGATE LIABILITY WITH RESPECT TO ITS OBLIGATIONS UNDER THIS AGREEMENT OR OTHERWISE WITH RESPECT TO THE SOFTWARE AND DOCUMENTATION OR OTHERWISE SHALL BE EQUAL TO THE PURCHASE PRICE, BUT SHALL IN NO EVENT EXCEED THE PRODUCT'S PRICE, BECAUSE SOME STATES/COUNTRIES DO NOT ALLOW THE EXCLUSION OR LIMITATION OF LIABILITY FOR CONSEQUENTIAL OR INCIDENTAL DAMAGES, THE ABOVE LIMITATION MAY NOT APPLY TO YOU.

8. Export Restrictions

THIS LICENSE AGREEMENT IS EXPRESSLY MADE SUBJECT TO ANY APPLICABLE LAWS, REGULATIONS, ORDERS, OR OTHER RESTRICTIONS ON THE EXPORT OF THE SOFTWARE OR INFORMATION ABOUT SUCH SOFTWARE WHICH MAY BE IMPOSED FROM TIME TO TIME. YOU SHALL NOT EXPORT THE SOFTWARE, DOCUMENTATION OR INFORMATION ABOUT THE SOFTWARE AND DOCUMENTATION WITHOUT COMPLYING WITH SUCH LAWS, REGULATIONS, ORDERS, OR OTHER RESTRICTIONS. YOU AGREE TO INDEMNIFY ZyXEL AGAINST ALL CLAIMS, LOSSES, DAMAGES, LIABILITIES, COSTS AND EXPENSES, INCLUDING REASONABLE ATTORNEYS' FEES, TO THE EXTENT SUCH CLAIMS ARISE OUT OF ANY BREACH OF THIS SECTION 8.

9. Audit Rights

ZyXEL SHALL HAVE THE RIGHT, AT ITS OWN EXPENSE, UPON REASONABLE PRIOR NOTICE, TO PERIODICALLY INSPECT AND AUDIT YOUR RECORDS TO ENSURE YOUR COMPLIANCE WITH THE TERMS AND CONDITIONS OF THIS LICENSE AGREEMENT.

10. Termination

This License Agreement is effective until it is terminated. You may terminate this License Agreement at any time by destroying or returning to ZyXEL all copies of the Software and Documentation in your possession or under your control. ZyXEL may terminate this License Agreement for any reason, including, but not limited to, if ZyXEL finds that you have violated any of the terms of this License Agreement. Upon notification of termination, you agree to destroy or return to ZyXEL all copies of the Software and Documentation and to certify in writing that all known copies, including backup copies, have been destroyed. All provisions

relating to confidentiality, proprietary rights, and non-disclosure shall survive the termination of this Software License Agreement.

12. General

This License Agreement shall be construed, interpreted and governed by the laws of Republic of China without regard to conflicts of laws provisions thereof. The exclusive forum for any disputes arising out of or relating to this License Agreement shall be an appropriate court or Commercial Arbitration Association sitting in ROC, Taiwan. This License Agreement shall constitute the entire Agreement between the parties hereto. This License Agreement, the rights granted hereunder, the Software and Documentation shall not be assigned by you without the prior written consent of ZyXEL. Any waiver or modification of this License Agreement shall only be effective if it is in writing and signed by both parties hereto. If any part of this License Agreement is found invalid or unenforceable by a court of competent jurisdiction, the remainder of this License Agreement shall be interpreted so as to reasonably effect the intention of the parties.

Legal Information

Certifications

Federal Communications Commission (FCC) Interference Statement

The device complies with Part 15 of FCC rules. Operation is subject to the following two conditions:

- This device may not cause harmful interference.
- This device must accept any interference received, including interference that may cause undesired operations.

This device has been tested and found to comply with the limits for a Class B digital device pursuant to Part 15 of the FCC Rules. These limits are designed to provide reasonable protection against harmful interference in a residential installation. This device generates, uses, and can radiate radio frequency energy, and if not installed and used in accordance with the instructions, may cause harmful interference to radio communications. However, there is no guarantee that interference will not occur in a particular installation.

If this device does cause harmful interference to radio/television reception, which can be determined by turning the device off and on, the user is encouraged to try to correct the interference by one or more of the following measures:

- 1 Reorient or relocate the receiving antenna.
- 2 Increase the separation between the equipment and the receiver.
- 3 Connect the equipment into an outlet on a circuit different from that to which the receiver is connected.
- 4 Consult the dealer or an experienced radio/TV technician for help.

Notices

Changes or modifications not expressly approved by the party responsible for compliance could void the user's authority to operate the equipment. This Class B digital apparatus complies with Canadian ICES-003. Cet appareil numérique de la classe B est conforme à la norme NMB-003 du Canada.

Viewing Certifications

- 1 Go to <http://www.zyxel.com>.
- 2 Select your product on the ZyXEL home page to go to that product's page.
- 3 Select the certification you wish to view from this page.

ZyXEL Limited Warranty

ZyXEL warrants to the original end user (purchaser) that this product is free from any defects in materials or workmanship for a period of up to two years from the date of purchase. During the warranty period, and upon proof of purchase, should the product have indications of failure due to faulty workmanship and/or materials, ZyXEL will, at its discretion, repair or replace the defective products or components without charge for either parts or labor, and to whatever extent it shall deem necessary to restore the product or components to proper operating condition. Any replacement will consist of a new or re-manufactured functionally equivalent product of equal or higher value, and will be solely at the discretion of ZyXEL. This warranty shall not apply if the product has been modified, misused, tampered with, damaged by an act of God, or subjected to abnormal working conditions.

Note

Repair or replacement, as provided under this warranty, is the exclusive remedy of the purchaser. This warranty is in lieu of all other warranties, express or implied, including any implied warranty of merchantability or fitness for a particular use or purpose. ZyXEL shall in no event be held liable for indirect or consequential damages of any kind to the purchaser.

To obtain the services of this warranty, contact ZyXEL's Service Center for your Return Material Authorization number (RMA). Products must be returned Postage Prepaid. It is recommended that the unit be insured when shipped. Any returned products without proof of purchase or those with an out-dated warranty will be repaired or replaced (at the discretion of ZyXEL) and the customer will be billed for parts and labor. All repaired or replaced products will be shipped by ZyXEL to the corresponding return address, Postage Paid. This warranty gives you specific legal rights, and you may also have other rights that vary from country to country.

Registration

Register your product online to receive e-mail notices of firmware upgrades and information at www.zyxel.com for global products, or at www.us.zyxel.com for North American products.

Related Documentation

Please go to <http://www.zyxel.com> for product news, firmware, documentation, and other support materials.

Copyright

Copyright © 2010 by ZyXEL Communications Corporation.

The contents of this publication may not be reproduced in any part or as a whole, transcribed, stored in a retrieval system, translated into any language, or transmitted in any form or by any means, electronic, mechanical, magnetic, optical, chemical, photocopying, manual, or otherwise, without the prior written permission of ZyXEL Communications Corporation.

Published by ZyXEL Communications Corporation. All rights reserved.

Disclaimer

ZyXEL does not assume any liability arising out of the application or use of any products, or software described herein. Neither does it convey any license under its patent rights nor the patent rights of others. ZyXEL further reserves the right to make changes in any products described herein without notice. This publication is subject to change without notice.

Trademarks

ZyNOS (ZyXEL Network Operating System) is a registered trademark of ZyXEL Communications, Inc. Other trademarks mentioned in this publication are used for identification purposes only and may be properties of their respective owners.